

Description

The LM5D15PN03 uses advanced trench technology to provide excellent $R_{DS(ON)}$, low gate charge and operation with gate voltages as low as 4.5V. This device is suitable for use as a Battery protection or in other Switching application.

General Features

$V_{DS} = 30V$ $I_D = 18A$
 $R_{DS(ON)} < 22m\Omega$ @ $V_{GS}=10V$ (Typ.15m Ω)
 $V_{DS} = -30V$ $I_D = -15A$
 $R_{DS(ON)} < 32m\Omega$ @ $V_{GS}=-10V$ (Typ.25m Ω)

Application

- Wireless charging
- Boost driver
- Brushless motor

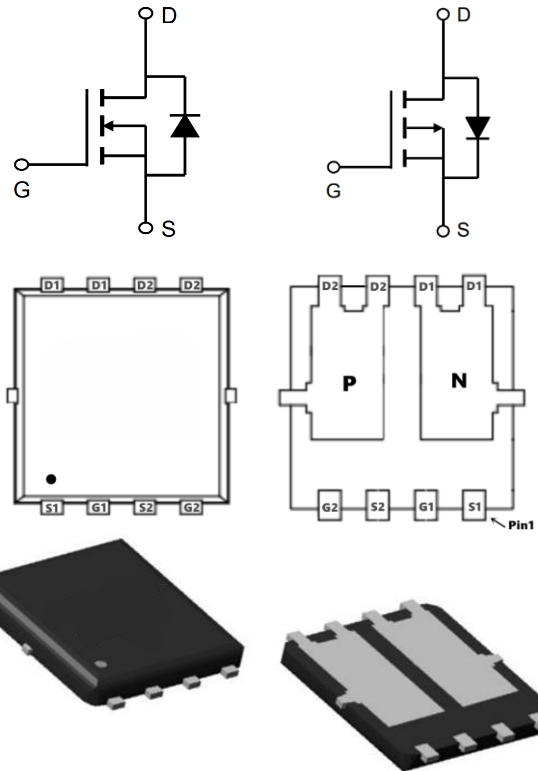

Package Marking and Ordering Information

Device	Device Marking	Device Package	Reel Size	Tape width	Quantity
LM5D15PN03	AP15G03NF	DFN5X6-8	-	-	5000 units

Absolute Maximum Ratings ($T_c=25^\circ\text{C}$ unless otherwise noted)

Symbol	Parameter	Rating		Units
		N-Ch	P-Ch	
VDS	Drain-Source Voltage	30	-30	V
VGS	Gate-Source Voltage	± 20	± 20	V
$I_D @ T_A=25^\circ\text{C}$	Continuous Drain Current, $V_{GS} @ 10V^1$	18	-15	A
$I_D @ T_A=100^\circ\text{C}$	Continuous Drain Current, $V_{GS} @ 10V^1$	10	-8	A
IDM	Pulsed Drain Current ²	52	-45	A
EAS	Single Pulse Avalanche Energy ³	22	45	mJ
IAS	Avalanche Current	21	-30	A
$P_D @ T_A=25^\circ\text{C}$	Total Power Dissipation ⁴	18	18	W
TSTG	Storage Temperature Range	-55 to 150	-55 to 150	$^\circ\text{C}$
T_J	Operating Junction Temperature Range	-55 to 150	-55 to 150	$^\circ\text{C}$
$R_{\theta JA}$	Thermal Resistance Junction-Ambient ¹	55		$^\circ\text{C/W}$
$R_{\theta JA}$	Thermal Resistance Junction-Ambient ¹ ($t \leq 10\text{sec}$)	5		$^\circ\text{C/W}$

Electrical Characteristics (T_J=25°C, unless otherwise noted)

Symbol	Parameter	Conditions	Min.	Typ.	Max.	Unit
BV _{DSS}	Drain-Source Breakdown Voltage	V _{GS} =0V, I _D =250uA	30	32.5	---	V
R _{DS(ON)}	Static Drain-Source On-Resistance ²	V _{GS} =10V, I _D =10A	---	15	22	mΩ
		V _{GS} =4.5V, I _D =5A	---	20	30	
V _{GS(th)}	Gate Threshold Voltage	V _{GS} =V _{DS} , I _D =250uA	1.0	1.6	2.5	V
I _{DSS}	Drain-Source Leakage Current	V _{DS} =24V, V _{GS} =0V, T _J =25°C	---	---	1	uA
		V _{DS} =24V, V _{GS} =0V, T _J =55°C	---	---	5	
I _{GSS}	Gate-Source Leakage Current	V _{GS} =±20V, V _{DS} =0V	---	---	±100	nA
g _{fs}	Forward Transconductance	V _{DS} =5V, I _D =10A	---	16	---	S
R _g	Gate Resistance	V _{DS} =0V, V _{GS} =0V, f=1MHz	---	2.5	5	Ω
Q _g	Total Gate Charge (4.5V)	V _{DS} =20V, V _{GS} =4.5V, I _D =10A	---	7.2	---	nC
Q _{gs}	Gate-Source Charge		---	1.4	---	
Q _{gd}	Gate-Drain Charge		---	2.2	---	
T _{d(on)}	Turn-On Delay Time	V _{DD} =15V, V _{GS} =10V, R _G =3.3Ω, I _D =5A	---	4.1	---	ns
T _r	Rise Time		---	9.8	---	
T _{d(off)}	Turn-Off Delay Time		---	15.5	---	
T _f	Fall Time		---	6.0	---	
C _{iss}	Input Capacitance	V _{DS} =15V, V _{GS} =0V, f=1MHz	---	572	---	pF
C _{oss}	Output Capacitance		---	81	---	
C _{rss}	Reverse Transfer Capacitance		---	65	---	
I _s	Continuous Source Current ^{1,5}	V _G =V _D =0V, Force Current	---	---	10	A
V _{SD}	Diode Forward Voltage ²	V _{GS} =0V, I _s =1A, T _J =25°C	---	---	1.2	V

Note :

- 1、 The data tested by surface mounted on a 1 inch² FR-4 board with 2OZ copper.
- 2、 The data tested by pulsed , pulse width ≅ 300us , duty cycle ≅ 2%
- 3、 The EAS data shows Max. rating . The test condition is V_{DD}=25V,V_{GS}=10V,L=0.1mH,I_{AS}=10A
- 4、 The power dissipation is limited by 150°C junction temperature
- 5、 The data is theoretically the same as I_D and I_{DM} , in real applications , should be limited by total power dissipation.

Electrical Characteristics (T_J=25°C, unless otherwise noted)

Symbol	Parameter	Conditions	Min.	Typ.	Max.	Unit
BV _{DSS}	Drain-Source Breakdown Voltage	V _{GS} =0V, I _D =-250uA	-30	-33	---	V
R _{DS(ON)}	Static Drain-Source On-Resistance ²	V _{GS} =-10V, I _D =-7A	---	25	32	mΩ
		V _{GS} =-4.5V, I _D =-5A	---	37	54	
V _{GS(th)}	Gate Threshold Voltage	V _{GS} =V _{DS} , I _D =-250uA	-1.0	---	-2.5	V
I _{DSS}	Drain-Source Leakage Current	V _{DS} =-24V, V _{GS} =0V, T _J =25°C	---	---	1	uA
		V _{DS} =-24V, V _{GS} =0V, T _J =55°C	---	---	5	
I _{GSS}	Gate-Source Leakage Current	V _{GS} =±20V, V _{DS} =0V	---	---	±100	nA
g _{fs}	Forward Transconductance	V _{DS} =-5V, I _D =-7A	---	15	---	S
R _g	Gate Resistance	V _{DS} =0V, V _{GS} =0V, f=1MHz		15	30	
Q _g	Total Gate Charge (-4.5V)		---	9.8	---	nC
Q _{gs}	Gate-Source Charge	V _{DS} =-20V, V _{GS} =-4.5V, I _D =-7A	---	2.2	---	
Q _{gd}	Gate-Drain Charge		---	3.4	---	
T _{d(on)}	Turn-On Delay Time	V _{DD} =-15V, V _{GS} =-10V, R _G =3.3, I _D =-5A	---	16.4	---	ns
T _r	Rise Time		---	20.2	---	
T _{d(off)}	Turn-Off Delay Time		---	55	---	
T _f	Fall Time		---	10	---	
C _{iss}	Input Capacitance	V _{DS} =-15V, V _{GS} =0V, f=1MHz	---	930	---	pF
C _{oss}	Output Capacitance		---	148	---	
C _{rss}	Reverse Transfer Capacitance		---	115	---	
I _s	Continuous Source Current ^{1,5}	V _G =V _D =0V, Force Current	---	---	-8	A
V _{SD}	Diode Forward Voltage ²	V _{GS} =0V, I _s =-1A, T _J =25°C	---	---	-1.2	V

Note :

- 1、 The data tested by surface mounted on a 1 inch² FR-4 board with 2OZ copper.
- 2、 The data tested by pulsed, pulse width ≅ 300us, duty cycle ≅ 2%
- 3、 The EAS data shows Max. rating. The test condition is V^{DD}=-25V, V_{GS}=-10V, L=0.1mH, I^{AS}=-10A
- 4、 The power dissipation is limited by 150°C junction temperature
- 5、 The data is theoretically the same as I_D and I_{DM}, in real applications, should be limited by total power dissipation.

N-Typical Characteristics

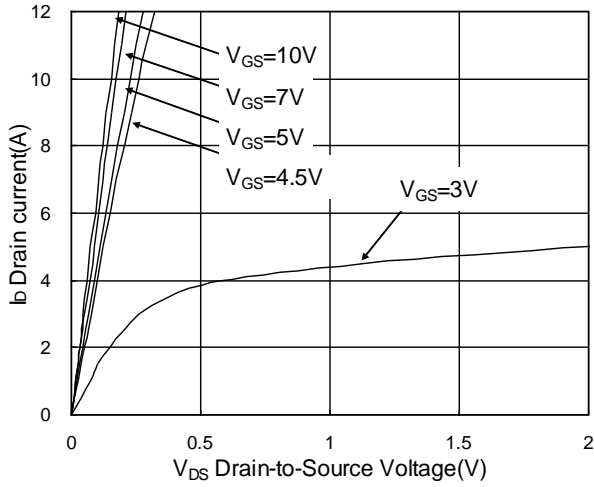

Fig.1 Typical Output Characteristics

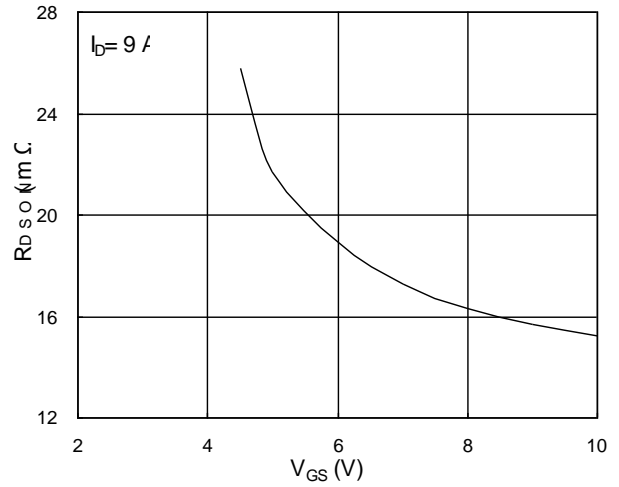

Fig.2 On-Resistance v.s Gate-Source

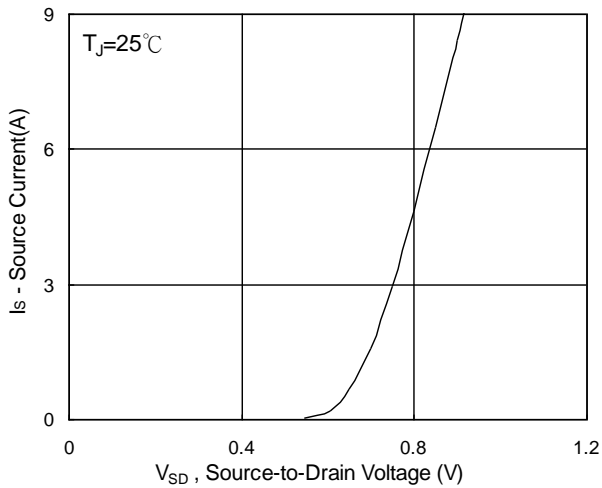

Fig.3 Forward Characteristics Of Reverse

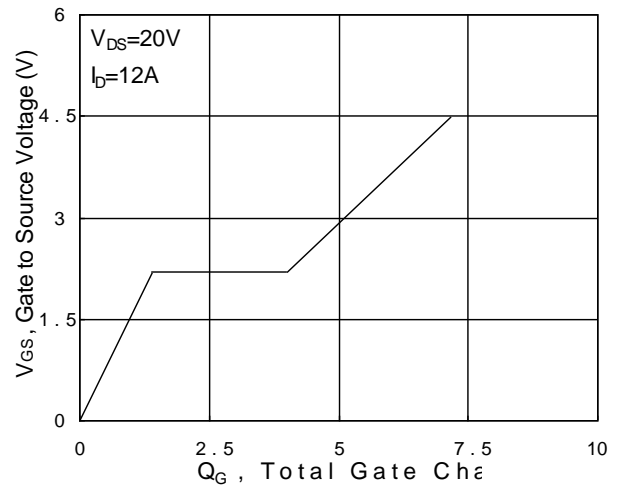

Fig.4 Gate-Charge characteristics

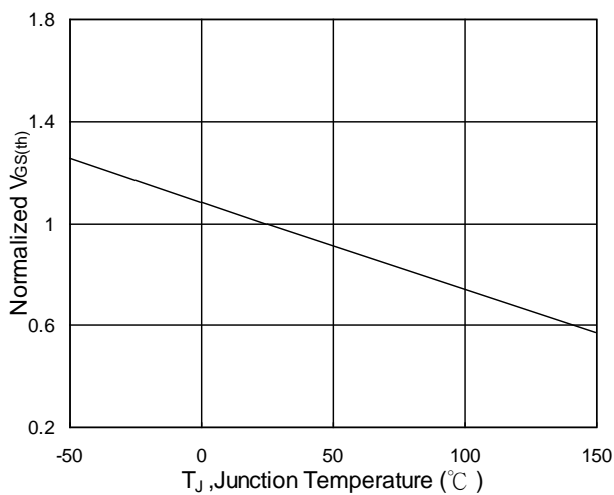

Fig.5 Normalized V_{GS(th)} v.s T_J

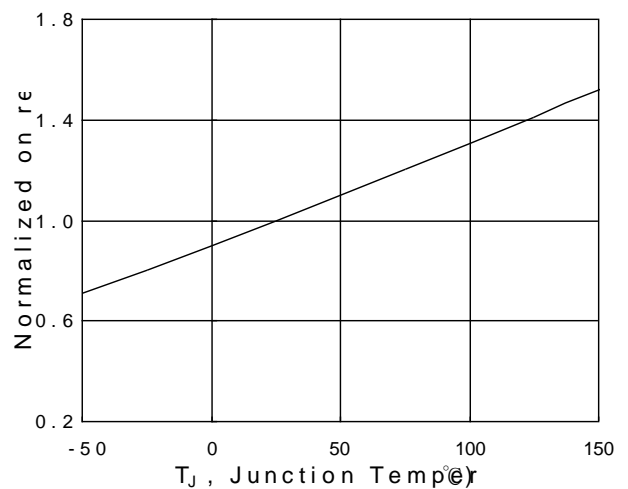

Fig.6 Normalized R_{DS(on)} v.s T_J

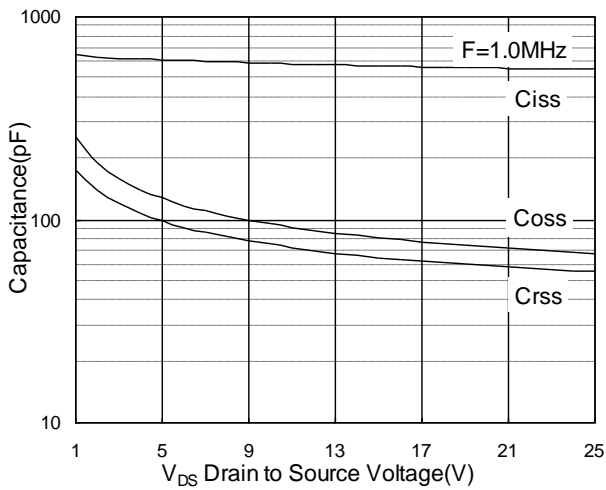

Fig.7 Capacitance

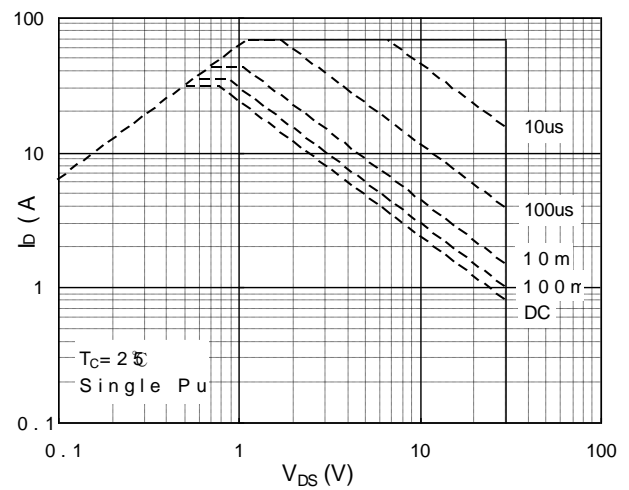

Fig.8 Safe Operating Area

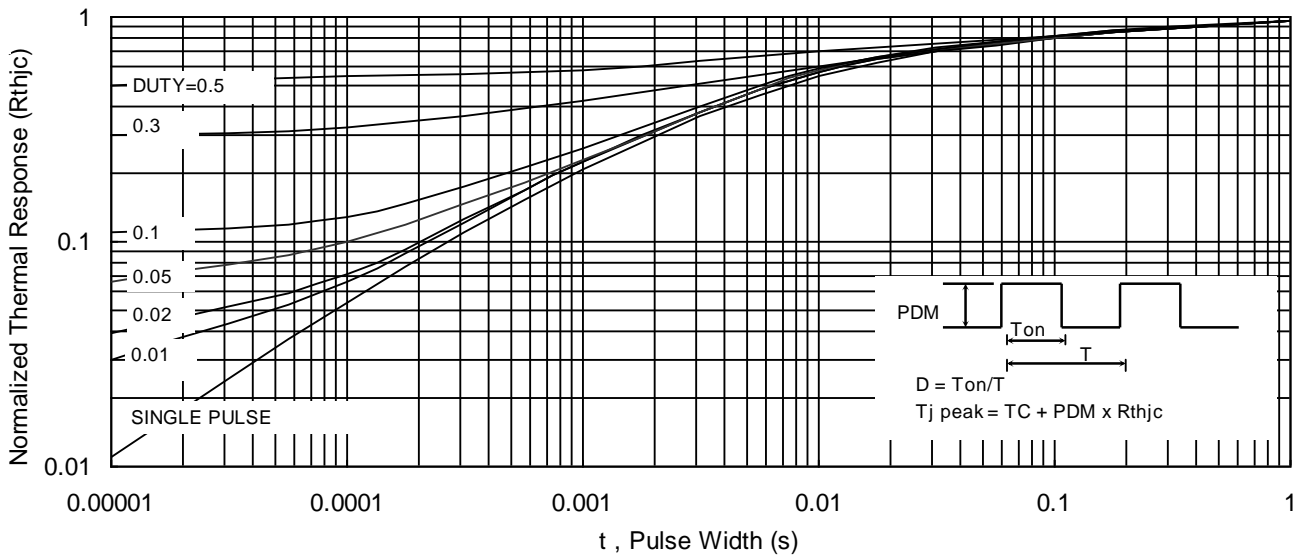

Fig.9 Normalized Maximum Transient Thermal Impedance

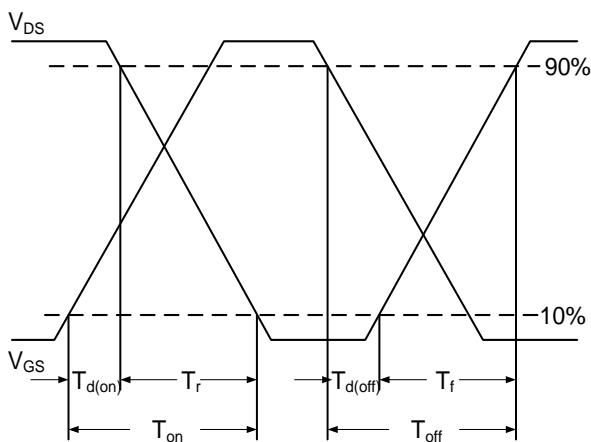

Fig.10 Switching Time Waveform

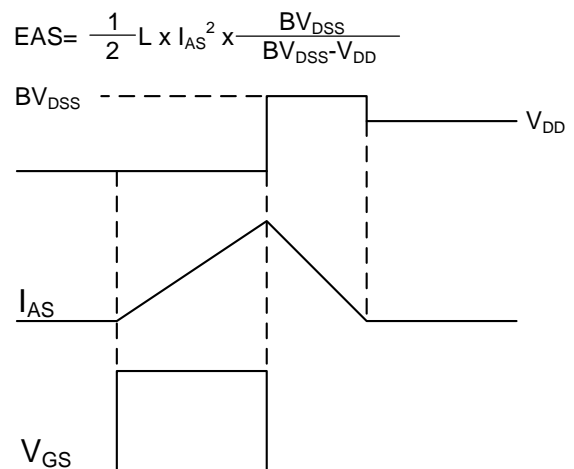

Fig.11 Unclamped Inductive Waveform

P-Typical Characteristics

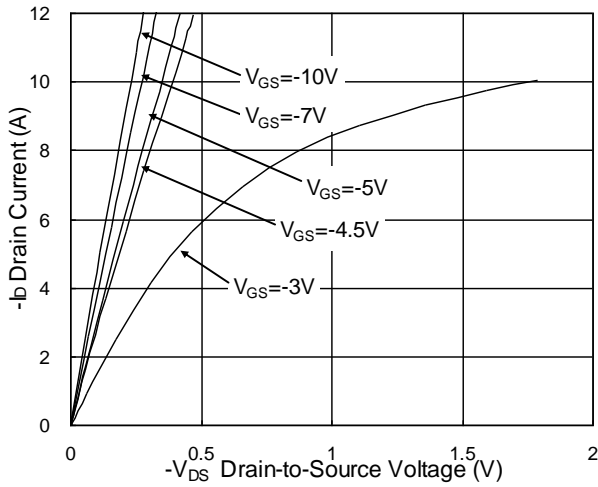

Fig.1 Typical Output Characteristics

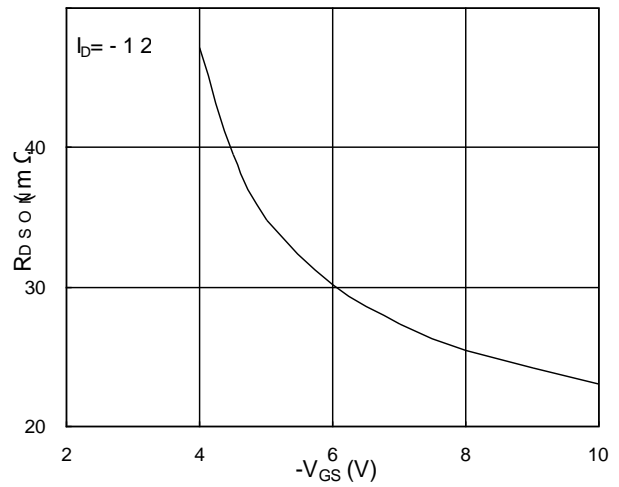

Fig.2 On-Resistance v.s Gate-Source

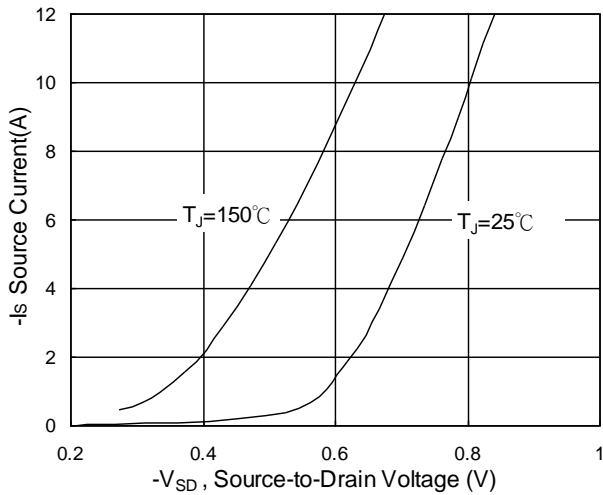

Fig.3 Forward Characteristics Of Reverse

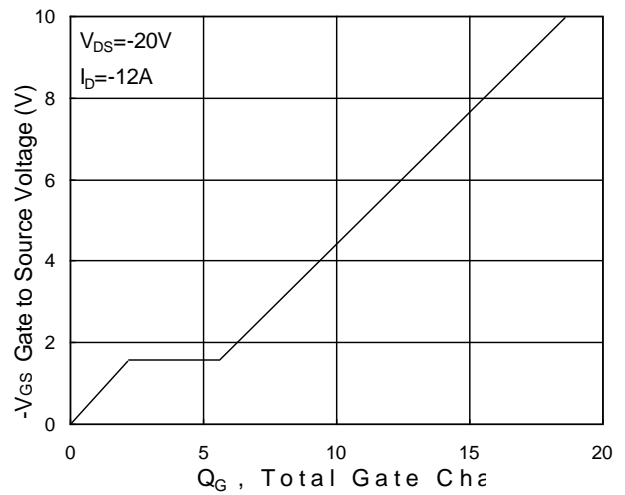

Fig.4 Gate-Charge Characteristics

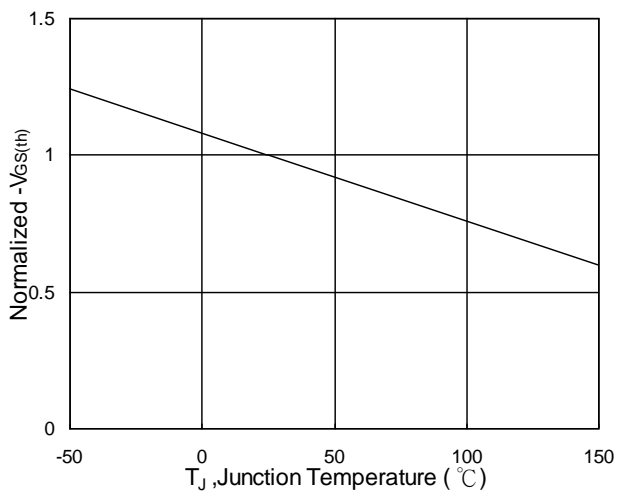

Fig.5 Normalized V_{GS(th)} v.s T_J

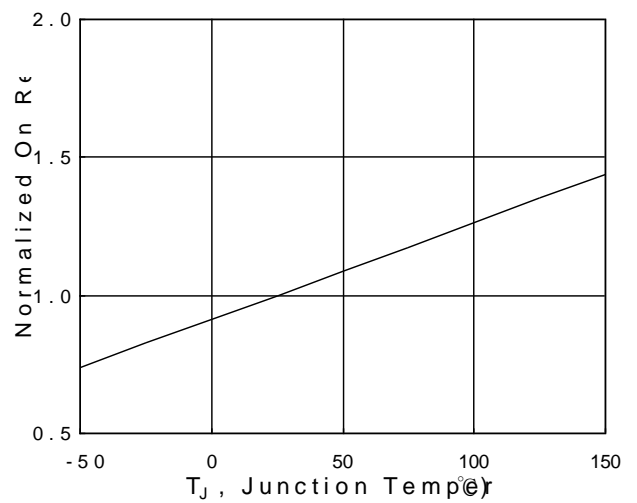

Fig.6 Normalized R_{DS(on)} v.s T_J

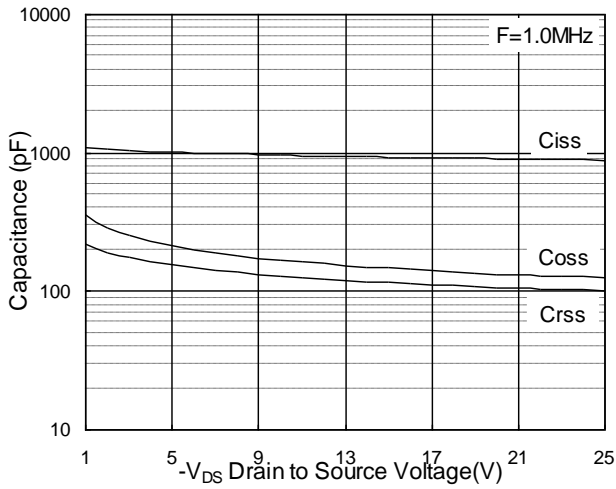

Fig.7 Capacitance

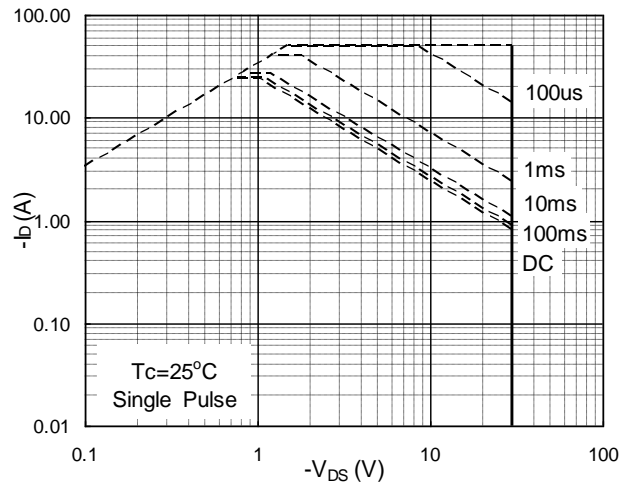

Fig.8 Safe Operating Area

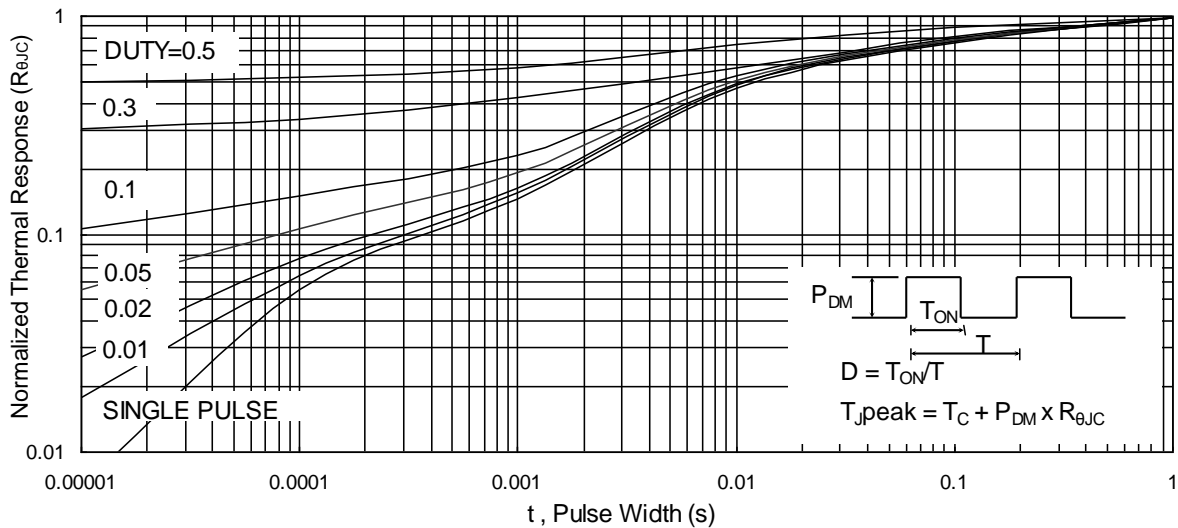

Fig.9 Normalized Maximum Transient Thermal Impedance

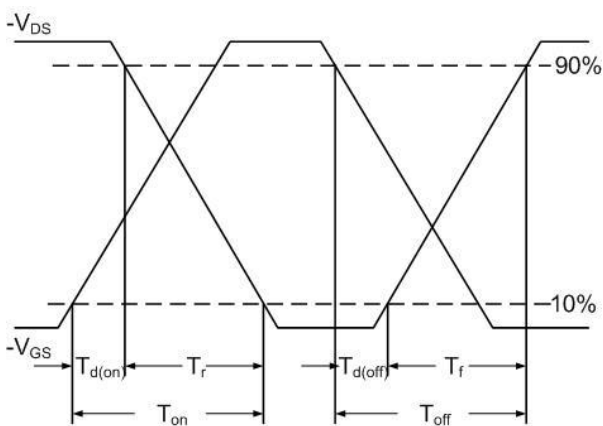

Fig.10 Switching Time Waveform

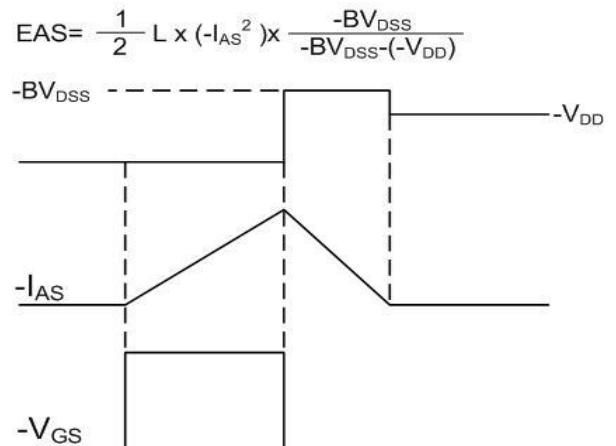
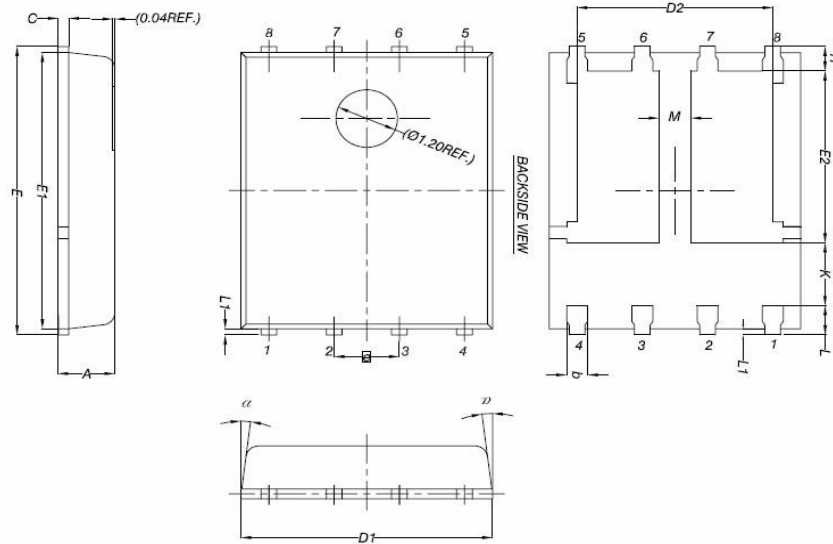

Fig.11 Unclamped Inductive Waveform

Package Mechanical Data-DFN5*6-8-JQ Double



Symbol	Common		
	mm		
	Mim	Nom	Max
A	0.90	1.00	1.10
b	0.33	0.41	0.51
C	0.20	0.25	0.30
D1	4.80	4.90	5.00
D2	3.61	3.81	3.96
E	5.90	6.00	6.10
E1	5.66	5.76	5.83
E2	3.37	3.47	3.58
e	1.27BSC		
H	0.41	0.51	0.61
K	1.10	--	--
L	0.51	0.61	0.71
L1	0.06	0.13	0.20
M	0.50	--	--
a	0°	--	12°