

**Description**

The LCEP3090GU uses **Super Trench** technology that is uniquely optimized to provide the most efficient high frequency switching performance. Both conduction and switching power losses are minimized due to an extremely low combination of $R_{DS(ON)}$ and Q_g . This device is ideal for high-frequency switching and synchronous rectification.

General Features

- $V_{DS}=30V, I_D=90A$
- $R_{DS(ON)}=2m\Omega$ (typical) @ $V_{GS}=10V$
- $R_{DS(ON)}=3.1m\Omega$ (typical) @ $V_{GS}=4.5V$
- Excellent gate charge x $R_{DS(on)}$ product(FOM)
- Very low on-resistance $R_{DS(on)}$
- 150 °C operating temperature
- Pb-free lead plating
- 100% UIS tested

Application

- DC/DC Converter
- Ideal for high-frequency switching and synchronous rectification

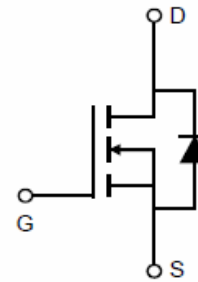

Schematic Diagram

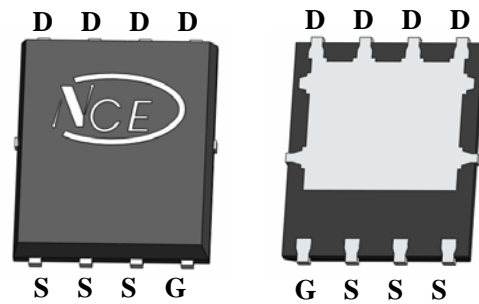

Top View

Bottom View

100% UIS TESTED!**100% ΔVds TESTED!****Package Marking and Ordering Information**

Device Marking	Device	Device Package	Reel Size	Tape width	Quantity
NCEP3090GU	LCEP3090GU	DFN5X6-8	-	-	-

Absolute Maximum Ratings ($T_C=25^\circ C$ unless otherwise noted)

Parameter	Symbol	Limit	Unit
Drain-Source Voltage	V_{DS}	30	V
Gate-Source Voltage	V_{GS}	± 20	V
Drain Current-Continuous	I_D	90	A
Drain Current-Continuous($T_C=100^\circ C$)	$I_D(100^\circ C)$	63.6	A
Pulsed Drain Current	I_{DM}	360	A
Maximum Power Dissipation	P_D	70	W
Derating factor		0.56	W/°C
Single pulse avalanche energy ^(Note 5)	E_{AS}	500	mJ
Operating Junction and Storage Temperature Range	T_J, T_{STG}	-55 To 150	°C

**Thermal Characteristic**

Thermal Resistance, Junction-to-Case ^(Note 2)	$R_{\theta JC}$	1.8	°C/W
--	-----------------	-----	------

Electrical Characteristics ($T_C=25^\circ\text{C}$ unless otherwise noted)

Parameter	Symbol	Condition	Min	Typ	Max	Unit
Off Characteristics						
Drain-Source Breakdown Voltage	BV_{DSS}	$V_{GS}=0V, I_D=250\mu A$	30		-	V
Zero Gate Voltage Drain Current	I_{DSS}	$V_{DS}=30V, V_{GS}=0V$	-	-	1	μA
Gate-Body Leakage Current	I_{GSS}	$V_{GS}=\pm 20V, V_{DS}=0V$	-	-	± 100	nA
On Characteristics ^(Note 3)						
Gate Threshold Voltage	$V_{GS(th)}$	$V_{DS}=V_{GS}, I_D=250\mu A$	1.0	1.5	2.0	V
Drain-Source On-State Resistance	$R_{DS(on)}$	$V_{GS}=10V, I_D=20A$	-	2	2.3	m Ω
		$V_{GS}=4.5V, I_D=20A$	-	3.1	3.6	m Ω
Forward Transconductance	g_{FS}	$V_{DS}=5V, I_D=20A$		60	-	S
Dynamic Characteristics ^(Note 4)						
Input Capacitance	C_{iss}	$V_{DS}=15V, V_{GS}=0V,$ $F=1.0\text{MHz}$	-	2100	-	PF
Output Capacitance	C_{oss}		-	773	-	PF
Reverse Transfer Capacitance	C_{rss}		-	15.5	-	PF
Switching Characteristics ^(Note 4)						
Turn-on Delay Time	$t_{d(on)}$	$V_{DD}=15V, I_D=20A$ $V_{GS}=10V, R_G=1.6\Omega$	-	7.5	-	nS
Turn-on Rise Time	t_r		-	4.0	-	nS
Turn-Off Delay Time	$t_{d(off)}$		-	37	-	nS
Turn-Off Fall Time	t_f		-	7.5	-	nS
Total Gate Charge	Q_g	$V_{DS}=15V, I_D=20A,$ $V_{GS}=10V$	-	34.8	-	nC
Gate-Source Charge	Q_{gs}		-	6.2		nC
Gate-Drain Charge	Q_{gd}		-	5.1		nC
Drain-Source Diode Characteristics						
Diode Forward Voltage ^(Note 3)	V_{SD}	$V_{GS}=0V, I_S=20A$	-		1.2	V
Diode Forward Current ^(Note 2)	I_S		-	-	90	A
Reverse Recovery Time	t_{rr}	$T_J = 25^\circ\text{C}, I_F = I_S$ $di/dt = 100A/\mu s$ ^(Note 3)	-	14	-	nS
Reverse Recovery Charge	Q_{rr}		-	21	-	nC

Notes:

1. Repetitive Rating: Pulse width limited by maximum junction temperature.
2. Surface Mounted on FR4 Board, $t \leq 10$ sec.
3. Pulse Test: Pulse Width $\leq 300\mu s$, Duty Cycle $\leq 2\%$.
4. Guaranteed by design, not subject to production
5. EAS condition : $T_J=25^\circ\text{C}, V_{DD}=20V, V_G=10V, L=0.5\text{mH}, R_g=25\Omega$



Typical Electrical and Thermal Characteristics

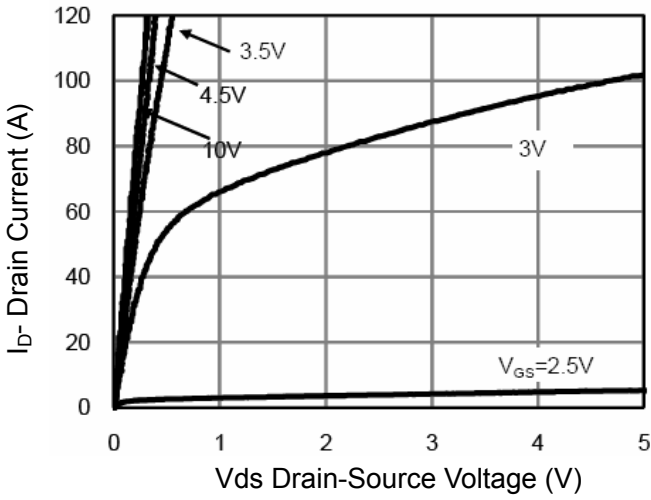

Figure 1 Output Characteristics

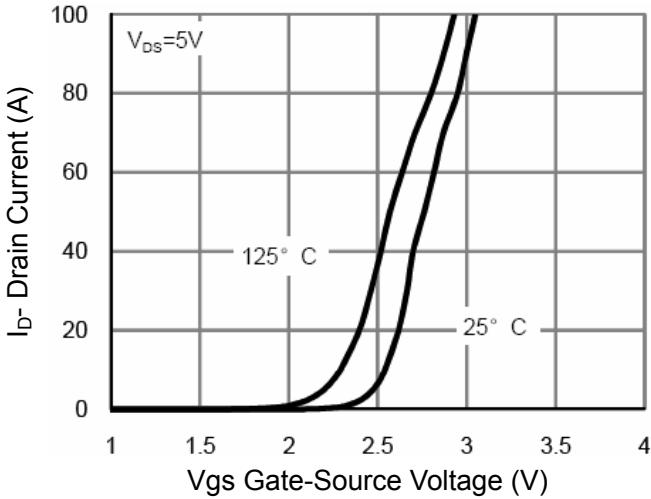

Figure 2 Transfer Characteristics

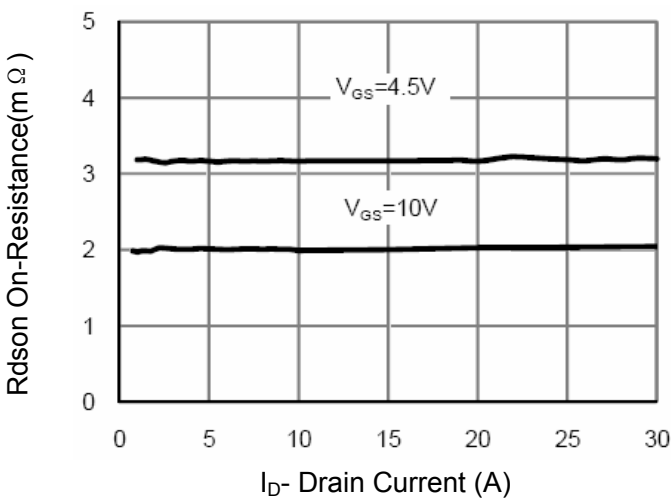

Figure 3 Rdson- Drain Current

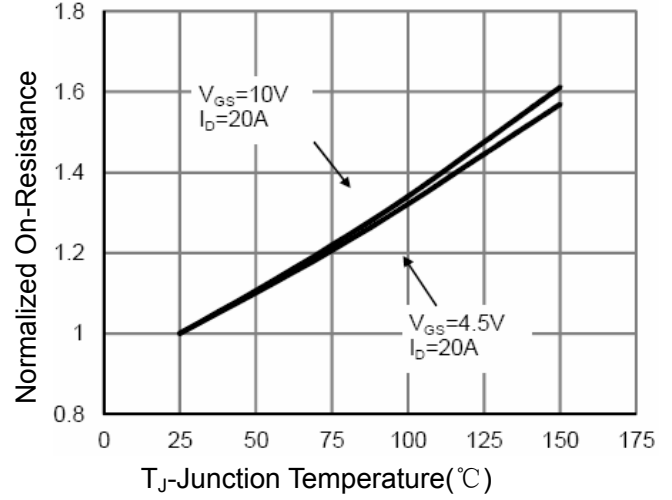

Figure 4 Rdson-Junction Temperature

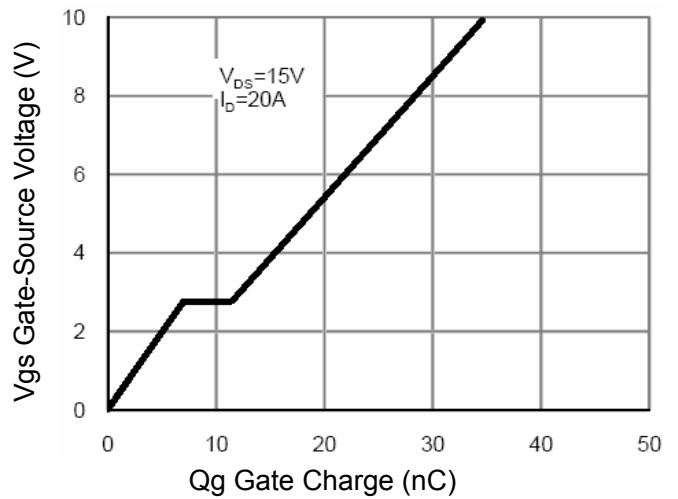

Figure 5 Gate Charge

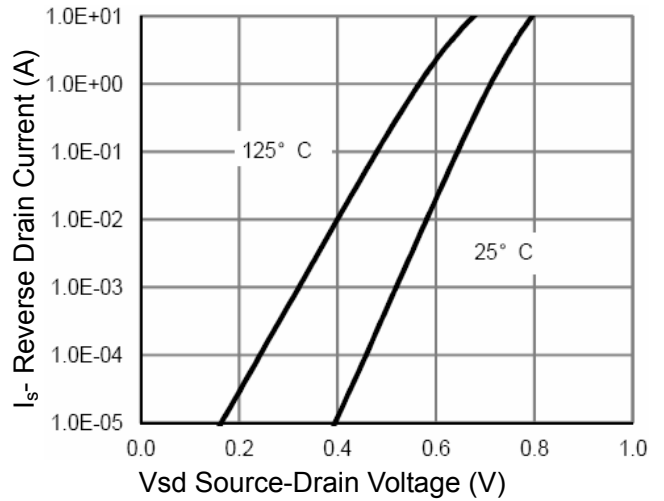

Figure 6 Source- Drain Diode Forward

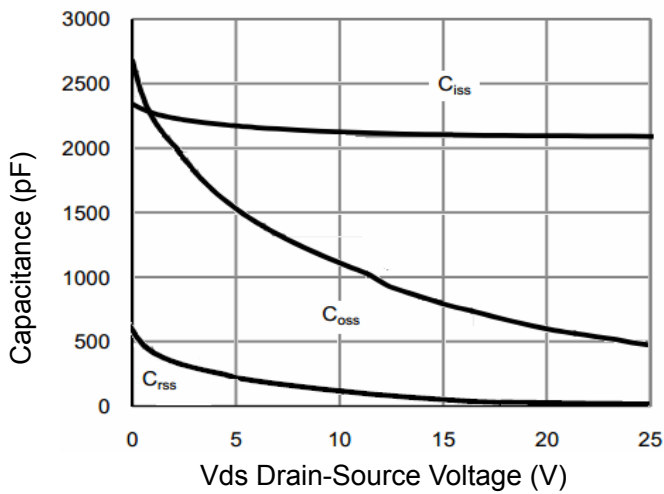

Figure 7 Capacitance vs Vds

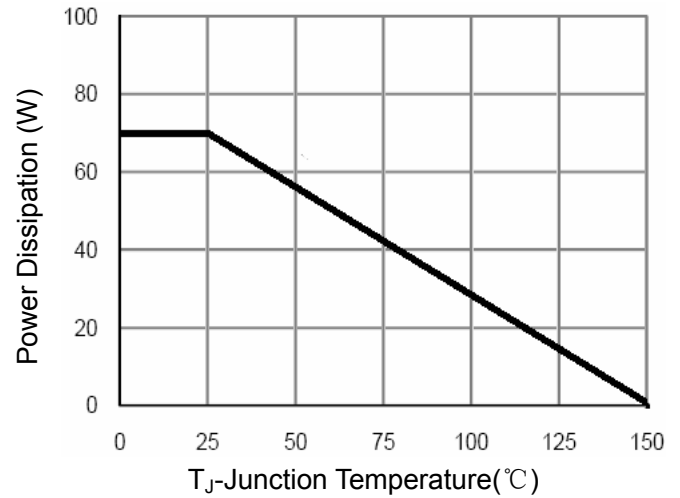

Figure 9 Power De-rating

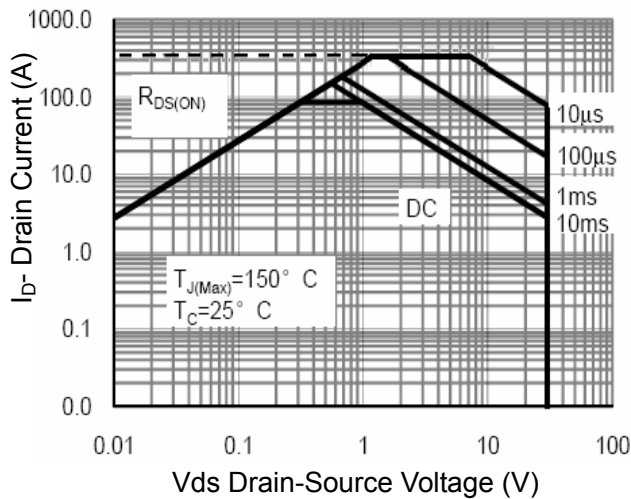

Figure 8 Safe Operation Area

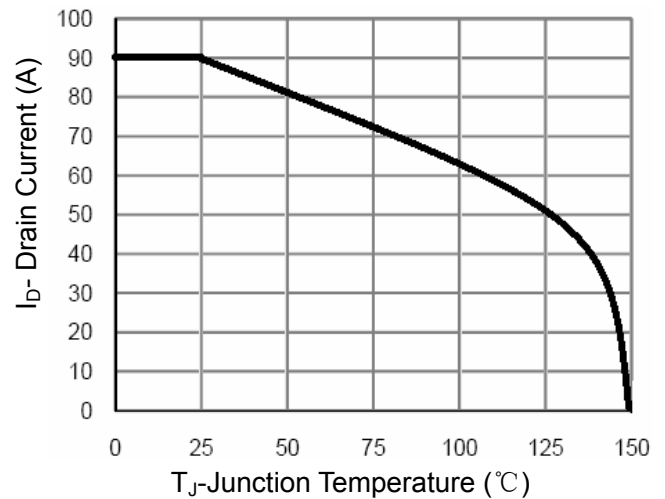

Figure 10 Current De-rating

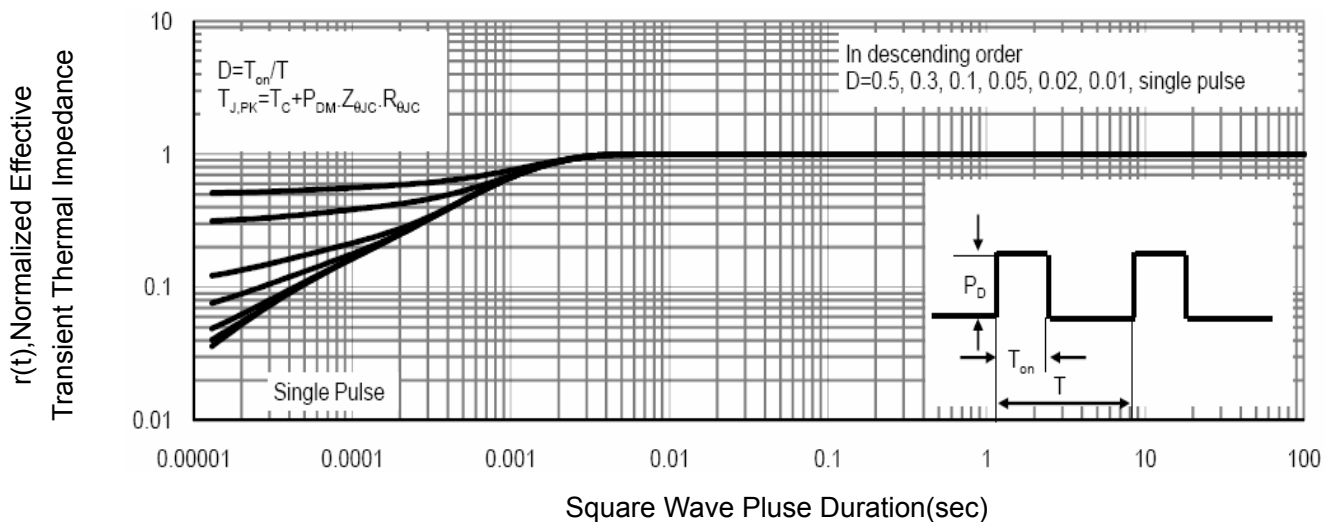
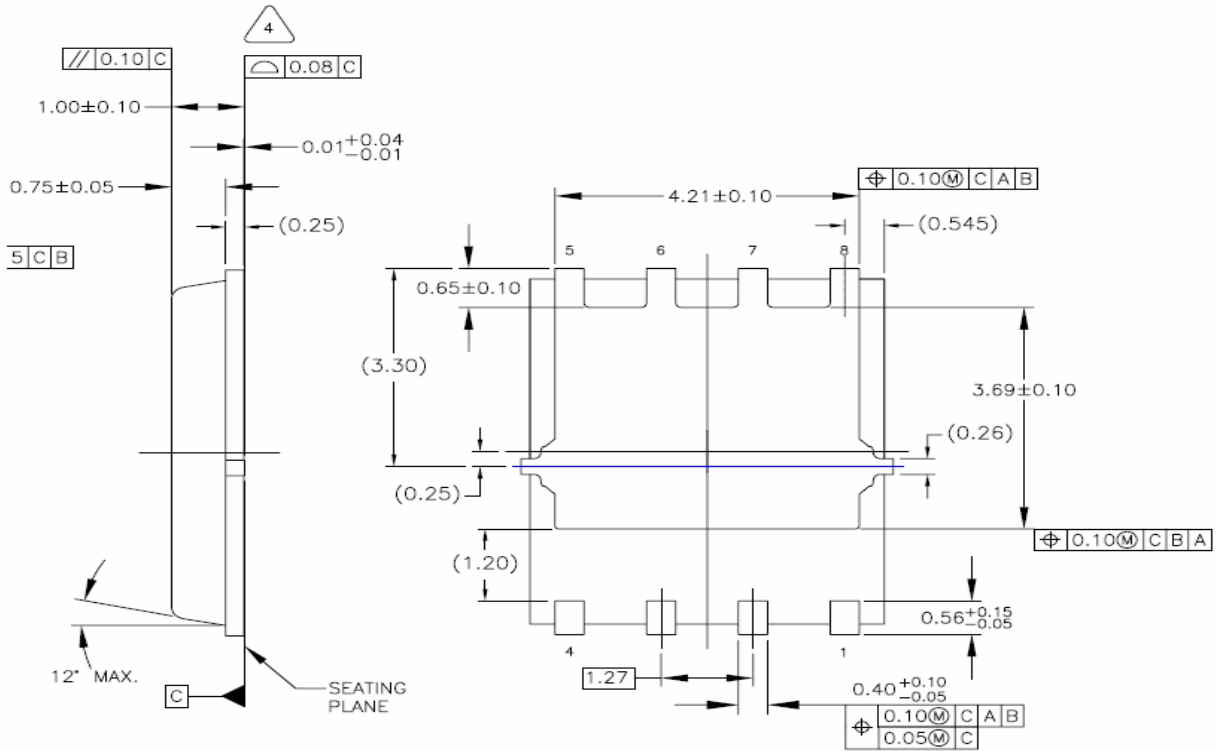
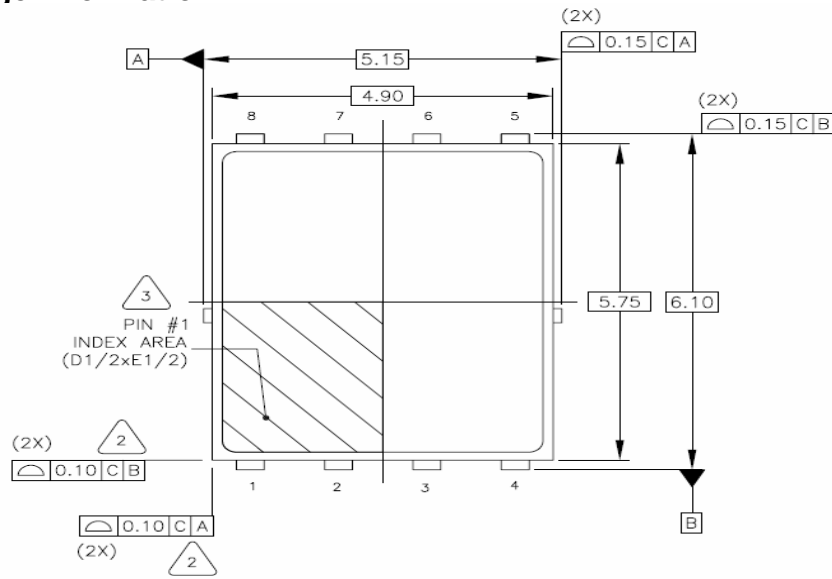

Figure 11 Normalized Maximum Transient Thermal Impedance



DFN5X6-8 Package Information



Shanghai Leiditech Electronic Co.,Ltd
Email: sale1@leiditech.com
Tel : +86- 021 50828806
Fax : +86- 021 50477059